

PINTI *buffet*  
MADE IN ITALY

---

CALEIDO

-  
2018

PINTI *buffet*  
MADE IN ITALY

---

CALEIDO

-

2018

PINTI BUFFET CALEIDO.....	5
SCEGLIE COMPONENTI / Choose and compose.....	6
I CALDI / Heated.....	9
I FREDDI / Refrigerating systems.....	17
INEUTRI / Neutral.....	35
LE BASI A PONTE / Display Bridge Base.....	51
IDISTRIBUTORI / Dispensers.....	57
PERSONALIZZAZIONE / Personalization.....	67
RICAMBI/ Spare Parts.....	69
GASTRONORM.....	70
NOTE INFORMATIVE / Technical Information.....	71

## CALEIDO

**Caleido** è la nuova linea di buffet progettata e realizzata da **Pinti Inox** per la ristorazione moderna, caratterizzata da:

### COMPLETEZZA DI GAMMA

La linea è composta da 10 basi perfettamente abbinabili tra loro, in grado di soddisfare tutte le esigenze, dal grande hotel al piccolo ristorante.

### VERSATILITÀ

Ogni articolo è composto da una base in acciaio e da una parte strutturale con misure Gastronorm: ciò garantisce un altissimo grado di personalizzazione e la massima intercambiabilità delle strutture per i vari momenti della giornata, dalla prima colazione alla cena.

### DESIGN MINIMAL

La semplicità delle forme rende la linea Caleido adatta sia a contesti classici, eleganti e formali, sia a location moderne e di tendenza.

### COLORE

Quattro i colori delle basi disponibili: **Salvia, Burro, Caffè, Carbone.**

Trovate l'acciaio troppo freddo? È possibile personalizzare i propri articoli inserendo bacinelle in porcellana bianca.

### ROBUSTEZZA

Le strutture sono realizzate in acciaio inox verniciato a polvere, adatte a un utilizzo intensivo, anche all'aperto.

### PERSONALIZZAZIONE

State cercando qualcosa di diverso? Richiedete un preventivo per personalizzare la Vostra sala con il colore e la composizione che avete in mente (per maggiori informazioni, vedete pag. 67)

**Caleido** is the new buffet line designed and manufactured by **Pinti Inox** following the modern catering trends asking for colour options, mix of materials and technical performance

### WIDE RANGE

This product line includes 10 bases that can be combined together to meet the needs of big hotels and small independent restaurants

### VERSATILITY

Each item is composed of a stainless steel base and a functional part following gastronorm standards. This make the buffet modular and easily adaptable to the different meals of the day from breakfast to dinner since the same base can be used with several functional parts

### MINIMAL DESIGN

The pure, neutral and minimal shape of the metal frames, makes Caleido buffet line suitable for all kind of location, from classic to modern

### COLOUR

The metal bases are available in 4 different colours: **Sage, Cream, Coffee, Coal.**

Do you think the plain stainless steel is a bit too cold? Just add some porcelain trays on your gastronorm basin.

### STRENGTH

All the structures are made of powder coated stainless steel, resistant to an intensive but also to an outdoor use.

### PERSONALIZATION















Are you looking for something different? Ask for a quote to personalize your room with the color and the composition you are thinking about (for additional information, have a look to page 67).

# SCEGLI E COMPONI

## Choose and compose

Cosa state cercando? Scegliete le parti funzionali nelle varie sezioni del catalogo (Caldi, Freddi, Neutri, Basi a Ponte e Distributori), quindi abbinatetele alle basi del colore che preferite.

**What are you looking for?** You can choose the functional components in the specific sections of our catalogue (Hot, Cold, Neutral, Display Bridge Base and Distributors) and then combine them to your favorite bases.

PARTI FUNZ. Functional parts BASI Stands	 <b>F180555</b>	 <b>F180556</b>	 <b>F1800950</b>	 <b>F1802900</b>	 <b>F1803100</b>	 <b>F1803300</b>	 <b>F1802830</b>	 <b>F1802820</b>	 <b>F1802840</b>
 <b>518_0001</b>			✓	✓	✓	✓	✓	✓	
 <b>518_0002</b>									✓
 <b>518_0003</b>	✓	✓							
 <b>518_0004</b>			✓		✓				
 <b>518_0006</b>									
 <b>518_0007</b>									

✓ I CALDI / Heated

✓ I FREDDI / Refrigerating systems

✓ I NEUTRI / Neutral

 F1802600	 F1806900	 F1807000	 F1806800	 F1800940	 F1800920	 F1803200	 F1805413	 F1805420	 F1809527
	✓	✓	✓	✓	✓	✓			
✓									
		✓			✓	✓			
							✓	✓	
									✓



# PINTI *buffet*

---

## CALEIDO

-

I CALDI

Heated

Les Articles Chauffés

Warmhaltesysteme

Sistemas Calientes





Bertolli  
MADE IN ITALY

## LA PARTE FUNZIONALE



Cod. F11805555  
CHAFING DISH  
High stand with steel border - Base haute avec protection en acier - Hoher Sockel mit Edelstahlrand - Base alta con plancha super.

### COMPOSIZIONE:

Cod. D05B5559  
1 VASCA BAGNOMARIA 1/1 h 110  
Gastronorm bain marie basin - Bac de bain-marie GN - Wasserbad-Wanne GN - Recipiente baño-maría GN

Cod. D05B5558  
1 COPERCHIO GN C/ POMOLO  
GN lid with knob - Couvercle GN avec pommeeu et - Gastronorm deckel mit Knopf - Tapa gastronómica GN con pomo

Cod. 5BA11065  
1 BACINELLA GN 1/1 h 65  
Gastronorm basin - Bac gastronorm - Durchbrochener basis - Cubeta gastronómica

Cod. 97200078  
2 FORNELLETTI INOX  
Stainless steel burner holder - Fourneau - Kocher - Quemadores

### OPTIONAL:

IL CHAFING DISH È PREDISPOSTO PER L'INSERIMENTO DELLA RESISTENZA ELETTRICA CON REGOLATORE

Cod. 97150118  
230 Volt 700 Watt  
The chafing dish can use a heater.

## LE BASI



Cod. 518A0003  
BASE ALTA SALVIA h cm 20  
High stand sage - Base haute vert - Hoher Sockel Salvia - Base alta verte



Cod. 518B0003  
BASE ALTA BURRO h cm 20  
High stand cream - Base haute crème - Hoher Sockel Burro - Base altar crema



Cod. 518C0003  
BASE ALTA CAFFÈ h cm 20  
High stand coffe - Base haute brun - Hoher Sockel Caffè - Base alta marron



Cod. 518D0003  
BASE ALTA CARBONE h cm 20  
High stand coal - Base haute gris - Hoher Sockel Carbone - Base alta gris



## CHAFING DISH RETTANGOLARE GN 1/1 CON CHIUSURA A FRIZIONE

GN complete rectangular chafing dish 1/1 friction closing.  
Chafing Dish rectangulaire GN1/1 avec fermeture à friction.  
Chafing Dish rechteckig GN 1/1 komplett mit Kupplungsschliessung.  
Cubeta GN 1/1 con cierre con fricción.



PINTELLI  
MADE IN ITALY

OPTIONAL

1/1

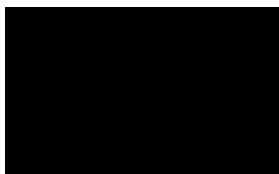

Cod. 97150785  
BACINELLA PORCELLANA 1/1 h cm 65  
China basin 1/1 - Bac en porcelaine -  
Porzellanschüssel - Cuenca de procelana



Cod. 97150786  
BACINELLA PORCELLANA 2/3 h cm 65  
China basin 2/3 - Bac en porcelaine -  
Porzellanschüssel - Cuenca de procelana

2/3



Cod. 97150787  
BACINELLA PORCELLANA 1/2 h cm 65  
China basin 1/2 - Bac en porcelaine -  
Porzellanschüssel - Cuenca de procelana



Cod. 97150788  
BACINELLA PORCELLANA 1/3 h cm 65  
China basin 1/3 - Bac en porcelaine -  
Porzellanschüssel - Cuenca de procelana

1/2

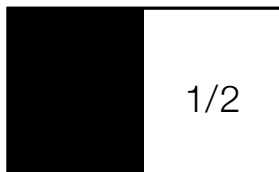

1/3

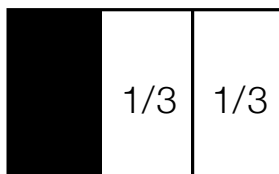



Penthouse  
MADE IN ITALY

Penthouse

## LA PARTE FUNZIONALE



Cod. F1805556  
ZUPPIERA RISCALDATA 2 STAZIONI  
2 Heated soup bowls - Soupière a 2 stations -  
Suppenstation - Sopera 2 staciones

### COMPOSIZIONE:

Cod. D0595559  
1 VASCA BAGNOMARIA 1/1  
h 110 C/GANCI  
Gastronorm bain marie basin - Bac de  
bain-marie GN - Wasserbad-Wanne GN -  
Recipiente baño-maría GN

Cod. 30595557  
1 COPERCHIO PORTA ZUPPIERA GN  
GN lid for soup bowl - Couvercle  
pour soupière GN - Deckel für  
Suppenschüsselhalter GN - Tapa porta-  
sopera GN

Cod. 30597222  
2 ZUPPIERE It 5 - Ø cm 22  
Soup bowl - Soupière - Suppenschüssel -  
Sopera

Cod. 30877522  
2 COPERCHI ZUPPIERA Ø cm 22  
Lid - Couvercle - Deckel - Tapa

Cod. 97200078  
2 FORNELLETTI INOX  
Stainless steel burner holder - Fourneau -  
Kocher - Quemadores

### OPTIONAL:

IL CHAFING DISH È PREDISPOSTO PER  
L'INSERIMENTO DELLA RESISTENZA  
ELETTRICA CON REGOLATORE  
Cod. 97150118  
230 Volt 700 Watt  
The chafing dish can use a heater.

## LE BASI



Cod. 518A0003  
BASE ALTA SALVIA h cm 20  
High stand sage - Base haute vert - Hoher  
Sockel Salvia - Base alta verte



Cod. 518B0003  
BASE ALTA BURRO h cm 20  
High stand cream - Base haute crème -  
Hoher Sockel Burro - Base altar crema



Cod. 518C0003  
BASE ALTA CAFFÈ h cm 20  
High stand coffe - Base haute brun - Hoher  
Sockel Caffè - Base alta marron



Cod. 518D0003  
BASE ALTA CARBONE h cm 20  
High stand coal - Base haute gris - Hoher  
Sockel Carbone - Base alta gris



## ZUPPIERA 2 STAZIONI RISCALDATA It 10

2 Heated soup bowls.  
Soupière a 2 stations.  
Suppenstation.  
Sopera 2 staciones.



PINTI *buffet*

---

CALEIDO

-

I FREDDI

Refrigerating Systems

Les Articles Réfrigérés

Kühlsysteme

Sistemas Refrigerados





## LA PARTE FUNZIONALE



Cod. F1800950  
VASSOIO PER AFFETTATI REFRIGERATO  
Rectangular refrigerated tray with cover for sliced salami - Plateau rectangulaire réfrigérant avec cloche pour charcuterie. - Rechteckiges Tablett für gekühlten Aufschnitt mit Haube - Bandeja rectangular para fiambre en lonchas refrigerado con campana

### COMPOSIZIONE:

Cod. 5BA11020  
1 BACINELLA GN 1/1 h 20  
Gastronorm basin  
Bac gastronorm  
Durchbrochener basis  
Cubeta gastronormic

Cod. 5TI11040  
1 TEGLIA GN 1/1 h 40  
Gastronorm basin  
Plat gastronorm  
Durchbrochener blech  
Fuente gastronormic

Cod. 5FP11000  
1 FALSO FONDO FORATO PC 1/1  
Perforated PC false bottom  
Faux fond percé PC  
Gelochter falscher Boden PC  
Doble fondo perforado PC

Cod. 97150276  
4 GEL PACK cm 20x9,8  
Refrigerating brick  
Briquelette réfrigérante  
Kühlakku  
Refrigerad

Cod. 97150856  
1 CUPOLA RETT. APRIBILE PC  
Rectangular dome lid  
Cloche rectangulaire  
Rolltop  
Campana rectangular

## LE BASI



Cod. 518A0001  
BASE BASSA SALVIA h cm 7,5  
Low base sage - Base basse vert  
Niedrigen Basis Salvia - Base baja verte



Cod. 518B0001  
BASE BASSA BURRO h cm 7,5  
Low base cream - Base basse crème  
Niedrigen Basis Burro - Base baja crema



Cod. 518C0001  
BASE BASSA CAFFÈ h cm 7,5  
Low base coffee - Base basse brun  
Niedrigen Basis Caffè - Base baja marron



Cod. 518D0001  
BASE BASSA CARBONE h cm 7,5  
Low base coal - Base basse gris  
Niedrigen Basis Carbone - Base baja gris



## VASSOIO PER AFFETTATI REFRIGERATO

Rectangular refrigerated tray with cover for sliced salami.  
Plateau rectangulaire réfrigérant avec cloche pour charcuterie.  
Rechteckiges Tablett für gekühlten Aufschnitt mit Haube.  
Bandeja rectangular para fiambre en lonchas refrigerado con campana.



Pastificio  
MILK IN GLASS

Pastificio  
MILK IN GLASS

## LA PARTE FUNZIONALE



Cod. F1802900  
PORTA YOGURT FORATO (Ø cm 5,5) REFRIG.  
Refrigerated tray with 22 holes for yoghurt  
- Porte-yaourt réfrigérant à 22 trous  
- Joghurthalterschale, gekühlt mit 22 Plätzen  
- Porta-yogur refrigerado con 22 compartimentos

### COMPOSIZIONE:

Cod. 5BP11065  
1 BACINELLA GN PC 1/1 h 65  
PC Gastronorm basin  
Bac gastronorm PC  
Durchbrochener basis PC  
Cubeta gastronómica PC

Cod. 5BFY1120  
1 BACINELLA FORATA  
PER PORTA YOGURT  
Perforated tray for yoghurt  
Plateau percé porte-yaourt  
Gelochte Joghurthalterschale  
Cuenco perforado para porta-yogurt

Cod. 5FP11000  
1 FALSO FONDO FORATO PC  
Perforated PC false bottom  
Faux fond percé PC  
Gelochter falscher Boden PC  
Doble fondo perforado PC

Cod. 97150276  
4 GEL PACK cm 20x9,8  
Refrigerating brick  
Briquette réfrigérante  
Kühlakku  
Refrigerad

## LE BASI



Cod. 518A0001  
BASE BASSA SALVIA h cm 7,5  
Low base sage - Base basse vert  
Niedrigen Basis Salvia - Base baja verde



Cod. 518B0001  
BASE BASSA BURRO h cm 7,5  
Low base cream - Base basse crème  
Niedrigen Basis Burro - Base baja crema



Cod. 518C0001  
BASE BASSA CAFFÈ h cm 7,5  
Low base coffee - Base basse brun  
Niedrigen Basis Caffè - Base baja marron



Cod. 518D0001  
BASE BASSA CARBONE h cm 7,5  
Low base coal - Base basse gris  
Niedrigen Basis Carbone - Base baja gris

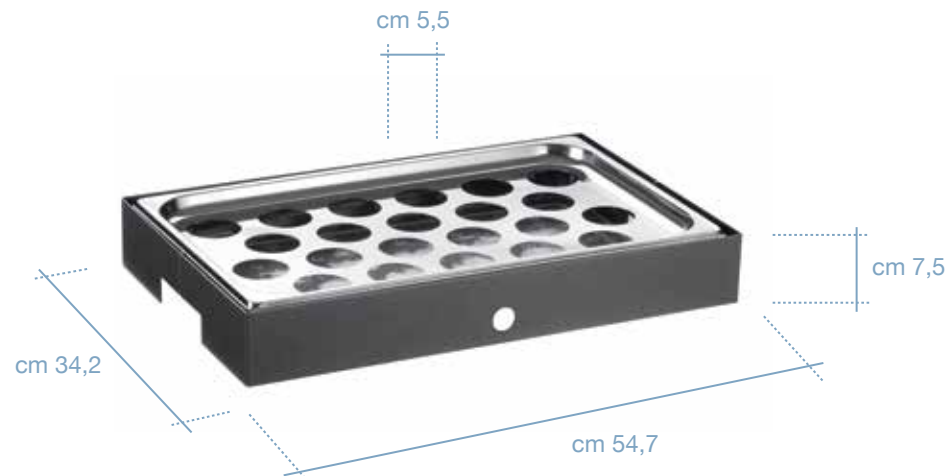

## VASSOIO PORTA YOGURT REFRIGERATO (22 FORI Ø cm 5,5)

Refrigerated tray with 22 holes for yoghurt.

Porte-yaourt réfrigérant à 22 trous.

Joghurthalterschale, gekühlt mit 22 Plätzen.

Porta-yogur refrigerado con 22 compartimentos.



## LA PARTE FUNZIONALE



Cod. F1803100  
PORTA BURRO E MARMELLATA REFRIG.  
Perforated and refrigerated tray with cover for jam and butter - Plateau percé réfrigérant avec cloche pour beurre et confiture - Gelochtes Butter- und Marmelade-Tablett, gekühlt mit Haube - Bandeja perforada para mantequilla y mermelada refrigerada con campana

### COMPOSIZIONE:

Cod. 5BA11040  
1 BACINELLA GN 1/1 h 40  
Gastronorm basin  
Bac gastronorm  
Durchbrochener basis  
Cubeta gastronormic

Cod. F1133100  
1 VASSOIO PORTABURRO FORATO  
Perforated butter tray  
Plateau percé pour beurre  
Butter-Tablett  
Mantequillera perforado

Cod. 5FP11000  
1 FALSO FONDO FORATO PC 1/1  
Perforated PC false bottom  
Faux fond percé PC  
Gelochter falscher Boden PC  
Doble fondo perforado PC

Cod. 97150276  
4 GEL PACK cm 20x9,8  
Refrigerating brick  
Briquette réfrigérante  
Kühlakku  
Refrigerad

Cod. 97150856  
1 CUPOLA RETT. APRIBILE PC  
Rectangular dome lid  
Cloche rectangulaire  
Rolltop  
Campana rectangular

## LE BASI



Cod. 518A0001  
BASE BASSA SALVIA h cm 7,5  
Low base sage - Base basse vert  
Niedrigen Basis Salvia - Base baja verde



Cod. 518B0001  
BASE BASSA BURRO h cm 7,5  
Low base cream - Base basse crème  
Niedrigen Basis Burro - Base baja crema



Cod. 518C0001  
BASE BASSA CAFFÈ h cm 7,5  
Low base coffee - Base basse brun  
Niedrigen Basis Caffè - Base baja marron



Cod. 518D0001  
BASE BASSA CARBONE h cm 7,5  
Low base coal - Base basse gris  
Niedrigen Basis Carbone - Base baja gris

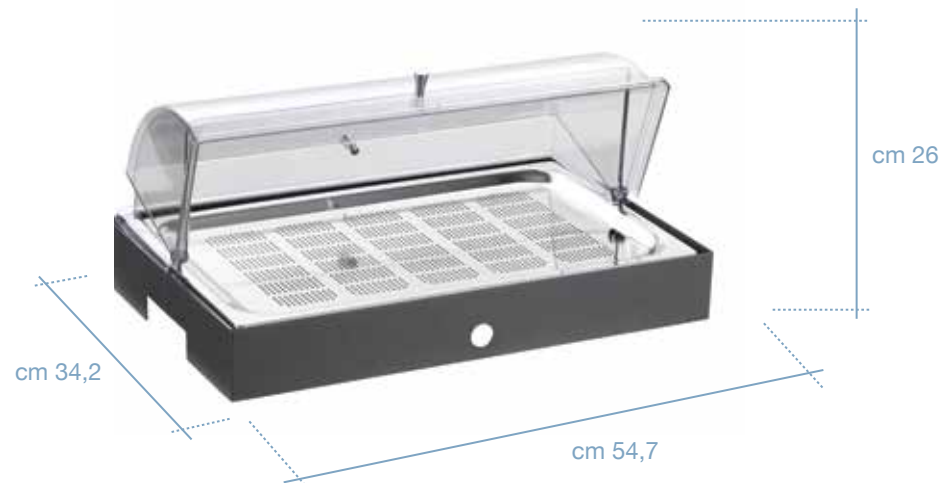

## VASSOIO FORATO PORTA BURRO E MARMELLATA REFRIGERATO

Perforated and refrigerated tray with cover for jam and butter.  
Plateau percé réfrigérant avec cloche pour beurre et confiture.  
Gelochtes Butter- und Marmelade-Tablett, gekühlt mit Haube.  
Bandeja perforada para mantequilla y mermelada refrigerada con campana.



## LA PARTE FUNZIONALE



Cod. F1803300  
PIASTRA ACCIAIO INOX REFRIGERATA  
Refrigerated stainless steel plate - Plaque réfrigérée - Gekühlte Edelstahlplatte - Placa de acero refrigerada

### COMPOSIZIONE:

Cod. 97150857  
1 PIASTRA INOX GN 1/1  
Refrigerated stainless steel plate  
Plaque réfrigérée  
Gekühlte Edelstahlplatte  
Placa de acero

Cod. 5T111020  
1 TEGLIA GN 1/1 h 20  
Gastronorm basin  
Plat gastronorm  
Durchbrochener blech  
Fuente gastronómico

Cod. 5FP11000  
1 FALSO FONDO FORATO PC  
Perforated PC false bottom  
Faux fond percé PC  
Gelochter falscher Boden PC - Doble fondo perforado PC

Cod. 97150276  
4 GEL PACK cm 20x9,8  
Refrigerating brick  
Brique réfrigérante  
Kühlakku  
Refrigerad

Cod. 97150856  
1 CUPOLA RETT. APRIBILE PC  
Rectangular dome lid  
Cloche rectangulaire  
Rolltop  
Campana rectangular

## LE BASI



Cod. 518A0001  
BASE BASSA SALVIA h cm 7,5  
Low base sage - Base basse vert  
Niedrigen Basis Salvia - Base baja verde



Cod. 518B0001  
BASE BASSA BURRO h cm 7,5  
Low base cream - Base basse crème  
Niedrigen Basis Burro - Base baja crema



Cod. 518C0001  
BASE BASSA CAFFÈ h cm 7,5  
Low base coffee - Base basse brun  
Niedrigen Basis Caffè - Base baja marron



Cod. 518D0001  
BASE BASSA CARBONE h cm 7,5  
Low base coal - Base basse gris  
Niedrigen Basis Carbone - Base baja gris



## PIASTRA ACCIAIO INOX REFRIGERATA

Refrigerated stainless steel plate.

Plateau rectangulaire réfrigérant avec cloche pour charcuterie.

Plaque réfrigérée en acier inox.

Placa de acero inoxidable refrigerada.





## LA PARTE FUNZIONALE



Cod. F1802830  
PORTA UOVA E VERDURA REFRIGERATO  
Double wall refrigerated GN tray with cover for eggs and vegetables - Double plateau GN réfrigérant à double paroi avec cloche pour œufs et légumes - Doppeltes Eier- und Gemüsetablett GN, doppelwandig, gekühlt mit Haube - Bandeja doble GN porta-huevos y verduras con doble pared refrigerada con campana

### COMPOSIZIONE:

Cod. FBAT1220  
1 VASSOIO PORTA UOVO GN 1/2  
Egg tray - Oeufrier - Eier-Tablett - Bandeja porta-huevos

Cod. 5BF12040  
1 BACINELLA GN 1/2 h 40 FORATA  
Perforated basin - Bac percé - Eier-Tablett - Cuenco perforado

Cod. 5BP12065  
2 BACINELLE GN PC 1/2 h 65  
PC Gastronorm basin - Bac gastronorm PC - Durchbrochener basis PC - Cubeta gastronormic PC

Cod. 5FP12000  
2 FALSI FONDI FORATI GN PC 1/2  
Perforated false bottom - Faux fond percé PC - Gelochter falscher Boden PC - Doble fondo perforado PC

Cod. 97150276  
4 GEL PACK cm 20x9,8  
Refrigerating brick - Briquette réfrigérante - Kühlakku - Refrigerad

Cod. 97150856  
1 CUPOLA RETT. APRIBILE PC  
Rectangular dome lid - Cloche rectangulaire - Rolltop - Campana rectangular

## LE BASI



Cod. 518A0001  
BASE BASSA SALVIA h cm 7,5  
Low base sage - Base basse vert  
Niedrigen Basis Salvia - Base baja verde



Cod. 518B0001  
BASE BASSA BURRO h cm 7,5  
Low base cream - Base basse crème  
Niedrigen Basis Burro - Base baja crema



Cod. 518C0001  
BASE BASSA CAFFÈ h cm 7,5  
Low base coffee - Base basse brun  
Niedrigen Basis Caffè - Base baja marron



Cod. 518D0001  
BASE BASSA CARBONE h cm 7,5  
Low base coal - Base basse gris  
Niedrigen Basis Carbone - Base baja gris



## VASSOIO PORTA UOVA E VERDURA REFRIGERATO

Double wall refrigerated tray with cover for eggs and vegetables.  
Double plateau réfrigérant à double paroi avec cloche pour œufs et légumes.  
Doppeltes Eier- und Gemüsetablett, doppelwandig, gekühlt mit Haube.  
Bandeja doble porta-huevos y verduras con doble pared refrigerada con campana.



PINTELLI  
MADE IN ITALY

PINTELLI  
MADE IN ITALY

## LA PARTE FUNZIONALE



Cod. F1802820  
PORTA VERDURE 4 SCOMPARTI REFRIG.  
Refrigerated basin with cover for vegetables  
- Plateau légumes réfrigérant avec cloche  
- Gemüseschalenhalter, gekühlt mit Haube  
- Porta-verduras refrigerado con campana

### COMPOSIZIONE:

Cod. 5BP11065  
1 BACINELLA GN PC 1/1 h 65  
Gastronorm basin  
Bac gastronorm  
Durchbrochener basis  
Cubeta gastronormic

Cod. 5BA28040  
4 BACINELLE GN 2/8 h 40  
Gastronorm basin  
Bac gastronorm  
Durchbrochener basis  
Cubeta gastronormic

Cod. 5FP11000  
1 FALSO FONDO GN PC 1/1  
h 65 FORATO  
PC Perforated false bottom  
Faux fond percé PC  
Gelochter falscher Boden PC  
Doble fondo perforado PC

Cod. 97150276  
4 GEL PACK cm 20x9,8  
Refrigerating brick  
Briquette réfrigérante  
Kühlakku  
Refrigerad

Cod. 97150856  
1 CUPOLA RETT. APRIBILE PC  
Rectangular dome lid  
Cloche rectangulaire  
Rolltop  
Campana rectangular

## LE BASI



Cod. 518A0001  
BASE BASSA SALVIA h cm 7,5  
Low base sage - Base basse vert  
Niedrigen Basis Salvia - Base baja verte



Cod. 518B0001  
BASE BASSA BURRO h cm 7,5  
Low base cream - Base basse crème  
Niedrigen Basis Burro - Base baja crema



Cod. 518C0001  
BASE BASSA CAFFÈ h cm 7,5  
Low base coffee - Base basse brun  
Niedrigen Basis Caffè - Base baja marron



Cod. 518D0001  
BASE BASSA CARBONE h cm 7,5  
Low base coal - Base basse gris  
Niedrigen Basis Carbone - Base baja gris



## VASSOIO PORTA VERDURE 4 SCOMPARTI REFRIGERATO

Refrigerated basin with cover for vegetables.  
Plateau légumes réfrigérant avec cloche.  
Gemüseschalenhalter, gekühlt mit Haube.  
Porta-verduras refrigerado con campana.



## LA PARTE FUNZIONALE



Cod. F1802840  
**PORTA YOGURT E VERDURE REFRIG.**  
 Double wall refrigeret basin with cover for yoghurt and vegetables - Plateau réfrigérant double paroi avec cloche pour yaourt et légumes - Joghurt- und Gemüseschalenhalter, doppelwandig, gekühlt mit Haube - Porta-yogur y verduras con doble pared refrigerada con campana

### COMPOSIZIONE:

Cod. D0595561  
 1 VASCA BAGNOMARIA 1/1  
 h 110 C/VITI  
 Gastronorm bain marie basin  
 Bac de bain-marie GN  
 Wasserbad-Wanne GN  
 Recipiente baño-maría GN

Cod. 5BP13100  
 3 BACINELLE GN PC 1/3 h 100  
 PC Gastronorm basin  
 Bac gastronorm PC  
 Durchbrochener basis PC  
 Cubeta gastronómico PC

Cod. 5FF11000  
 1 FALSO FONDO GN 1/1 FORATO  
 Perforated false bottom  
 Faux fond percé  
 Gelochter falscher Boden  
 Doble fondo perforado

Cod. 97150276  
 4 GEL PACK cm 20x9,8  
 Refrigerating brick  
 Briquette réfrigérante  
 Kühlakku  
 Refrigererad

Cod. 97150856  
 1 CUPOLA RETT. APRIBILE PC  
 Rectangular dome lid  
 Cloche rectangulaire  
 Rolltop  
 Campana rectangular



## LE BASI



Cod. 518A0002  
**BASE MEDIA SALVIA** h cm 12,5  
 Medium base sage - Base moyenne vert  
 Mittelgroße Basis Salvia - Base média verte



Cod. 518B0002  
**BASE MEDIA BURRO** h cm 12,5  
 Medium base cream - Base moyenne crème  
 Mittelgroße Basis Burro - Base media crema



Cod. 518C0002  
**BASE MEDIA CAFFÈ** h cm 12,5  
 Medium base coffee - Base moyenne brun  
 Mittelgroße Basis Caffè - Base media marron



Cod. 518D0002  
**BASE MEDIA CARBONE** h cm 12,5  
 Medium base coal - Base moyenne gris  
 Mittelgroße Basis Carbone - Base média gris



## VASSOIO PORTA YOGURT E VERDURE DOPPIA PARETE REFRIGERATO

Double wall refrigeret basin with cover for yoghurt and vegetables.  
 Plateau réfrigérant double paroi avec cloche pour yaourt et légumes.  
 Joghurt- und Gemüseschalenhalter, doppelwandig, gekühlt mit Haube.  
 Porta-yogur y verduras con doble pared refrigerada con campana.



## LA PARTE FUNZIONALE



Cod. F1802600  
VASCA GHIACCIO  
Ice bucket - Bac à galcon - Eisbehälter-  
Recipiente hielo

### COMPOSIZIONE:

Cod. 30595559  
1 VASCA CHAFING DISH 1/1 h 110  
Chafing dish basin  
Bac de chauffe-plats  
Chafing Dish basis  
Recipiente calentaplatos

Cod. 5TFC1140  
1 TEGLIA FORATA PER  
PORTA CHAMPAGNE  
Perforated tray for champagne  
Plateau rectangulaire pour champagne  
Gelochtes Blech für Champagner-Kübel  
Fuente perforada para porta-champagne

Cod. F1132600  
2 PENTOLE PORTA  
CHAMPAGNE It 7  
Champagne pot  
Bain-marie marmite pour champagne  
Champagner-Kübel  
Cubo porta-champagne

## LE BASI



Cod. 518A0002  
BASE MEDIA SALVIA h cm 12,5  
Medium base sage - Base moyenne vert  
Mittelgroße Basis Salvia - Base média verte



Cod. 518B0002  
BASE MEDIA BURRO h cm 12,5  
Medium base cream - Base moyenne crème  
Mittelgroße Basis Burro - Base média crema



Cod. 518C0002  
BASE MEDIA CAFFÈ h cm 12,5  
Medium base coffee - Base moyenne brun  
Mittelgroße Basis Caffè - Base média marron



Cod. 518D0002  
BASE MEDIA CARBONE h cm 12,5  
Medium base coal - Base moyenne gris  
Mittelgroße Basis Carbone - Base média gris



## VASCA GHIACCIO

Ice bucket.

Bac à glaçons.

Eisbehälter.

Recipiente hielo.





# PINTI *buffet*

---

## CALEIDO

-

I NEUTRI

Neutral

Les Articles Neutres

Neutral

Neutros



Piemonte  
MADE IN ITALY

## LA PARTE FUNZIONALE



Cod. F1806900  
CESTA PANE WENGE  
Wenge bread basket with cover - Corbeille à pain avec cloche - Brotkorb mit Haube - Cesto para el pan con campana



Cod. F1806700  
CESTA PANE PAGLIA  
Pail bread basket with cover - Corbeille à pain avec cloche - Brotkorb mit Haube - Cesto para el pan con campana

## COMPOSIZIONE:

Cod. 5T111040  
1 TEGLIA 1/1 h 40  
Gastronorm basin  
Plat gastronorm  
Durchbrochener blech  
Fuente gastronómico

Cod. L7150759  
1 CESTA PANE WENGE C/FORCELLE  
Wenge bread basket with hooks  
Corbeille a pain avec crochets  
Brotkorb mit Aufnahmegabeln für Haub  
Cesto para el pan con asas

Cod. L7150760  
1 CESTA PANE PAGLIA C/FORCELLE  
Pail bread basket with hooks  
Corbeille a pain avec crochets  
Brotkorb mit Aufnahmegabeln für Haub  
Cesto para el pan con asas

Cod. 97150856  
1 CUPOLA RETT. APRIBILE PC  
Rectangular dome lid- Cloche rectangulaire  
Rolltop - Campana rectangular

## LE BASI



Cod. 518A0001  
BASE BASSA SALVIA h cm 7,5  
Low base sage - Base basse vert  
Niedrigen Basis Salvia - Base baja verde



Cod. 518B0001  
BASE BASSA BURRO h cm 7,5  
Low base cream - Base basse crème  
Niedrigen Basis Burro - Base baja crema



Cod. 518C0001  
BASE BASSA CAFFÈ h cm 7,5  
Low base coffee - Base basse brun  
Niedrigen Basis Caffè - Base baja marron



Cod. 518D0001  
BASE BASSA CARBONE h cm 7,5  
Low base coal - Base basse gris  
Niedrigen Basis Carbone - Base baja gris



## CESTA PANE

Bread basket with cover.

Corbeille à pain avec cloche.

Brotkorb mit Haube.

Cesto para el pan con campana.



## LA PARTE FUNZIONALE



Cod. F1807000  
CESTA PANE IN TESSUTO  
Woven bread basket - Panièr pan en tissuts  
- Brotkorb aus Stoff - Cesto para el pan de tejido

### COMPOSIZIONE:

Cod. 5T111040  
1 TEGLIA 1/1 h 40  
Gastronorm basin  
Plat gastronorm  
Durchbrochener blech  
Fuente gastronòmic

Cod. 97150860  
1 CESTA PANE IN TESSUTO  
Woven bread basket  
Panièr pan en tissuts  
Brotkorb aus Stoff  
Cesto para el pan de tejido

Cod. 97150856  
1 CUPOLA RETT. APRIBILE PC  
Rectangular dome lid  
Cloche rectangulaire  
Rolltop  
Campana rectangular

## LE BASI



Cod. 518A0001  
BASE BASSA SALVIA h cm 7,5  
Low base sage - Base basse vert  
Niedrigen Basis Salvia - Base baja verte



Cod. 518B0001  
BASE BASSA BURRO h cm 7,5  
Low base cream - Base basse crème  
Niedrigen Basis Burro - Base baja crema



Cod. 518C0001  
BASE BASSA CAFFÈ h cm 7,5  
Low base coffee - Base basse brun  
Niedrigen Basis Caffè - Base baja marron



Cod. 518D0001  
BASE BASSA CARBONE h cm 7,5  
Low base coal - Base basse gris  
Niedrigen Basis Carbone - Base baja gris



## CESTA PANE IN TESSUTO

Woven bread basket.  
Panièr pain en tissuts.  
Brotkorb aus Stoff.  
Cesto para el pan de tejido.



## LA PARTE FUNZIONALE



Cod. F1806800  
TAGLIERE PANE IN LEGNO  
Bread board - Planche à couper le pain -  
Brotschneidebrett in Nussbaumfarbe - Tabla  
de cortar pan

### COMPOSIZIONE:

Cod. 5T111020  
1 TEGLIA GN 1/1 h 20  
Gastronorm basin  
Plat gastronorm  
Durchbrochener blech  
Fuente gastronómic

Cod. 97150859  
2 TAGLIERE PANE  
IN NOCE CANALETTO cm 27,5x34,5  
"Canaletto" walnut bread chopping board  
Coupe pain enuix "Canaletto"  
Brotschneidebrett in Nussbaumfarbe  
Tabla de noce de cortar pan

## LE BASI



Cod. 518A0001  
BASE BASSA SALVIA h cm 7,5  
Low base sage - Base basse vert  
Niedrigen Basis Salvia - Base baja verte



Cod. 518B0001  
BASE BASSA BURRO h cm 7,5  
Low base cream - Base basse crème  
Niedrigen Basis Burro - Base baja crema



Cod. 518C0001  
BASE BASSA CAFFÈ h cm 7,5  
Low base coffee - Base basse brun  
Niedrigen Basis Caffè - Base baja marron



Cod. 518D0001  
BASE BASSA CARBONE h cm 7,5  
Low base coal - Base basse gris  
Niedrigen Basis Carbone - Base baja gris

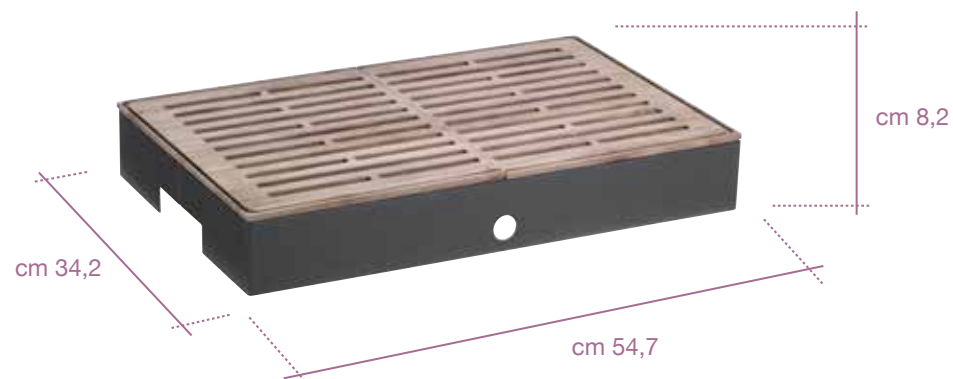

## TAGLIERE PANE IN NOCE CANALETTO

"Canaletto" walnut bread chopping board.

Planche à couper le pain.

Scneidbrett.

Brotschneidebrett in Nussbaumfarbe.





## LA PARTE FUNZIONALE



Cod. F1800940  
VASSOIO PER FORMAGGI  
Rectangular cheese tray with non-deformable polypropilene board - Plateau à fromages avec planche à découper en polypropylène - Rechteckiges Kaesetablett 1/1 aus Polypropylen mit Rolltop, hoher Widerstand - Bandeja rectangular para queso con tabla de polipropileno

### COMPOSIZIONE:

Cod. 97150858  
1 TAGLIERE IN POLIPROPILENE NERO cm 54,7x34,2  
Polypropilene board  
Hachoir en polypropylène  
Küchenbrett aus Polypropylen  
Tabla en polipropileno

Cod. 97150856  
1 CUPOLA RETT. APRIBILE PC  
Rectangular dome lid  
Cloche rectangulaire  
Rolltop  
Campana rectangular

## LE BASI



Cod. 518A0001  
BASE BASSA SALVIA h cm 7,5  
Low base sage - Base basse vert  
Niedrigen Basis Salvia - Base baja verde



Cod. 518B0001  
BASE BASSA BURRO h cm 7,5  
Low base cream - Base basse crème  
Niedrigen Basis Burro - Base baja crema



Cod. 518C0001  
BASE BASSA CAFFÈ h cm 7,5  
Low base coffee - Base basse brun  
Niedrigen Basis Caffè - Base baja marron



Cod. 518D0001  
BASE BASSA CARBONE h cm 7,5  
Low base coal - Base basse gris  
Niedrigen Basis Carbone - Base baja gris



## VASSOIO PER FORMAGGI CON TAGLIERE IN POLIPROPILENE

Rectangular cheese tray with non-deformable polypropilene board.  
Plateau à fromages avec planche à découper en polypropilène  
Rechteckiges Kaesetablett aus Polypropylen mit Rolltop, hoher Widerstand.  
Bandeja rectangular para queso con tabla de polipropileno.



Eveready  
MADE IN CHINA

## LA PARTE FUNZIONALE



Cod.F1800920  
VASSOIO PER PASTICCERIA  
Rectangular tray with cover for pastries  
- Plateau rectangulaire à pâtisserie -  
Rechteckiges tablett 1/1 mit rolltop - Bandeja  
rectangular para pastelería

### COMPOSIZIONE:

Cod. 5BAF1120  
1 BACINELLE GN 1/1 h 20  
Gastronorm bain marie basin  
Bac de bain-marie GN  
Wasserbad-Wanne GN  
Recipiente baño-maría GN

Cod. 97150856  
1 CUPOLE RETT. APRIBILE PC  
Rectangular dome lid  
Cloche rectangulaire  
Rolltop  
Campana rectangular

## LE BASI



Cod. 518A0001  
BASE BASSA SALVIA h cm 7,5  
Low base sage - Base basse vert  
Niedrigen Basis Salvia - Base baja verte



Cod. 518B0001  
BASE BASSA BURRO h cm 7,5  
Low base cream - Base basse crème  
Niedrigen Basis Burro - Base baja crema



Cod. 518C0001  
BASE BASSA CAFFÈ h cm 7,5  
Low base coffee - Base basse brun  
Niedrigen Basis Caffè - Base baja marron



Cod. 518D0001  
BASE BASSA CARBONE h cm 7,5  
Low base coal - Base basse gris  
Niedrigen Basis Carbone - Base baja gris



## VASSOIO PASTICCERIA

Rectangular tray with cover for pastries.  
Plateau rectangulaire à pâtisserie.  
Rechteckiges tablett 1/1 mit rolltop.  
Bandeja rectangular para pastelería.



## LA PARTE FUNZIONALE



Cod. F1803200  
PORTA FRUTTA  
Tray for fruit - Fruitier - Etagen-Obstschale -  
Frutero

### COMPOSIZIONE:

Cod. 5TIR1140  
1 TEGLIA GN 1/1 h 40  
C/RINGHIERE  
GN tray with edges  
Plat GN avec bords  
Bain-marie deckel mit schlitz  
Baño maria gastronomico



## LE BASI



Cod. 518A0001  
BASE BASSA SALVIA h cm 7,5  
Low base sage - Base basse vert  
Niedrigen Basis Salvia - Base baja verte



Cod. 518B0001  
BASE BASSA BURRO h cm 7,5  
Low base cream - Base basse crème  
Niedrigen Basis Burro - Base baja crema



Cod. 518C0001  
BASE BASSA CAFFÈ h cm 7,5  
Low base coffee - Base basse brun  
Niedrigen Basis Caffè - Base baja marron



Cod. 518D0001  
BASE BASSA CARBONE h cm 7,5  
Low base coal - Base basse gris  
Niedrigen Basis Carbone - Base baja gris



## PORTA FRUTTA

Tray for fruit.  
Fruitier.  
Etagen-Obstschale.  
Frutero.



## POSSIBILI COMBINAZIONI



BASE BASSA + ALZATA BASSA  
Low base + low display bridge



BASE BASSA + ALZATA MEDIA  
Low base + medium display bridge



BASE BASSA + ALZATA ALTA  
Low base + high display bridge



BASE MEDIA + ALZATA MEDIA  
Medium base + medium display bridge



Cod. 518A0008  
ALZATA ALTA SALVIA 57,5x17x30 h cm  
High display bridge sage - Plateau haute vert  
Hoher Etagerer Salvia - Pisos alta verte

Cod. 518A0009  
ALZATA MEDIA SALVIA 56,1x17x19,2 h cm  
Medium display bridge sage - Plateau moyenne vert  
Mittelgroße Etagerer Salvia - Pisos media verte

Cod. 518A0010  
ALZATA BASSA SALVIA 54,7x17x8,5 h cm  
Low display bridge sage - Plateau basse vert  
Niedrigen Etagerer Salvia - Pisos verte



Cod. 518C0008  
ALZATA ALTA CAFFÈ 57,5x17x30 h cm  
High display bridge coffee - Plateau haute brun  
Hoher Etagerer Caffè - Pisos alta marron

Cod. 518C0009  
ALZATA MEDIA CAFFÈ 56,1x17x19,2 h cm  
Medium display bridge coffee - Plateau moyenne brun  
Mittelgroße Etagerer Caffè - Pisos media marron

Cod. 518C0010  
ALZATA BASSA CAFFÈ 54,7x17x8,5 h cm  
Low display bridge coffee - Plateau basse brun  
Niedrigen Etagerer Caffè - Pisos marron



Cod. 518B0008  
ALZATA ALTA BURRO 57,5x17x30 h cm  
High display bridge cream - Plateau haute crème  
Hoher Etagerer Burro - Pisos alta crema

Cod. 518B0009  
ALZATA MEDIA BURRO 56,1x17x19,2 h cm  
Medium display bridge cream - Plateau moyenne crème  
Mittelgroße Etagerer Burro - Pisos media crema

Cod. 518B0010  
ALZATA BASSA BURRO 54,7x17x8,5 h cm  
low display bridge cream Plateau basse crème  
Niedrigen Etagerer Burro - Pisos crema



Cod. 518D0008  
ALZATA ALTA CARBONE 57,5x17x30 h cm  
High display bridge coal - Plateau haute gris  
Hoher Etagerer Carbone - Pisos alta gris

Cod. 518B0009  
ALZATA MEDIA CARBONE 56,1x17x19,2 h cm  
Medium display bridge coal - Plateau moyenne gris  
Mittelgroße Etagerer Carbone - Pisos media gris

Cod. 518D0010  
ALZATA BASSA CARBONE 54,7x17x8,5 h cm  
Low display bridge coal - Plateau basse gris  
Niedrigen Etagerer Carbone - Pisos gris





PINTI *buffet*

---

CALEIDO

-

LE BASI A PONTE

Display Bridge Base

Les Supports à Pont

Einsätze für Basis

Bandejas a Puente



Bxth  
buffet  
MADE IN ITALY

Bxth

## BASI



Cod. 518A0004  
BASE A PONTE SALVIA h cm 37,8  
Display Bridge base sage - Support  
à pont vert - Etagere Salvia -  
Bandejas a puente verde



Cod. 518B0004  
BASE A PONTE BURRO h cm 37,8  
Display Bridge base cream -  
Support à pont crème - Etagere  
Burro - Bandejas a puente crema



Cod. 518C0004  
BASE A PONTE CAFFÈ h cm 37,8  
Display Bridge base coffee -  
Support à pont brun - Etagere Caffè  
- Bandejas a puente marron



Cod. 518D0004  
BASE A PONTE CARBONE h cm 37,8  
Display Bridge base coal - Support  
à pont gris - Etagere Carbone -  
Bandejas a puente gris

# BASE A PONTE Display Bridge Base

## POSSIBILI ALLESTIMENTI:

Possible combinations (with Display Bridge Base):



Cod. F1807000  
CESTA PANE IN TESSUTO  
Woven bread basket



Cod. F1803100  
PORTA BURRO E MARMELLATA REFRIG.  
Perforated and refrigerated tray with cover  
for jam and butter



Cod. F1803200  
PORTA frutta  
Tray for fruit



Cod. F1800920  
VASSOIO PASTICCERIA  
Refrigerated tray for pastries



Cod. F1800950  
VASSOIO PER AFFETTATI REFRIGERATO  
Refrigerated tray with cover for sliced salami





# ALZATE 2 PIANI

## Double decker displays

**TUTTE LE COMBINAZIONI PER ALZATA 2 PIANI**  
**All the items that can be used under the display bridge base**  
**to create a double decker display**



VASSOIO PER AFFETTATI REFRIG.  
Refrigerated tray for sliced salami



PORTA BURRO-MARMEL. REFRIG.  
Refrigerated tray for jam and butter



PORTA VERDURE 4 SCOMP. REFR.  
Refrigerated basin for vegetables



TAGLIERE PANE  
Bread board



VASSOIO PASTICCERIA  
Tray for pastries



PORTA YOGURT REFRIG.  
Refrigerated tray with holes for yoghurt



PIASTRA ACCIAIO REFRIG.  
Refrigerated stainless steel plate



PORTA UOVO-VERDURE REFRIG.  
Refrigerated tray for eggs and vegetables



VASSOIO FORMAGGI  
Cheese tray



PORTA FRUTTA  
Tray for fruit



PINTI *buffet*

---

CALEIDO

-

I DISTRIBUTORI

Dispensers

Les Distributeurs

Spender

Distribuidores





## LA PARTE FUNZIONALE



Cod. F1805413  
DISTRIBUTORE SUCCHI It 5  
Juice and cold drink dispenser - Fontaine à jus de fruits simple paroi - Spender für Saft und kalte Getränke - Surtidor de zumos y bebidas con grifo Tomlinson

### COMPOSIZIONE:

Cod. 97150863  
1 CONTENITORE IN VETRO CON RUBINETTO It 5  
Juice dispenser with tap - Fontaine à jus de fruits avec robinet - Saftspender mit shahn - Surtidor de zumos con grifo

Cod. 97150865  
1 VASCHETTA PER DISTRIB. SUCCHI  
Juices bowl distributor - Petit bac pour fontaine à jus - Schale für Saftspender - Cubeta de surtidor de zumos

Cod. 97150866  
1 COPERCHIO PER VASCHETTA DISTR. SUCCHI  
Lid for juices bowl distributor - Couvercle petit bac pour fontaine à jus - Deckel für Saftspender - Tapa por cubeta de surtidor de zumos

Cod. 97150867  
1 GEL PACK cm 15x14  
Refrigerating brick - Briquette réfrigérante - Kühlakku - Refrigérad

Cod. 5BA16020  
1 BACINELLA GN 1/6 h 20  
Gastronorm basin - Bac gastronorm - Durchbrochener basis - Cubeta gastronómica

Cod. 50902613  
1 GRIGLIA 1/6 PER DISTRIBUTORE  
Grill for dispenser - Grille pour distributeur - Rost für Getränkedispenser - Baño maria gastronómico

## LE BASI



Cod. 518A0006  
BASE DISTRIBUT. SUCCHI SALVIA h cm 24  
Structure for juice dispenser sage - Structure pour distributeur à jus vert - Struktur für Saftdispenser Salvia - Estructura para dispensador de zumos verde



Cod. 518B0006  
BASE DISTRIBUT. SUCCHI BURRO h cm 24  
Structure for juice dispenser cream - Structure pour distributeur à jus crème - Struktur für Saftdispenser Burro - Estructura para dispensador de zumos crema



Cod. 518C0006  
BASE DISTRIBUT. SUCCHI CAFFÈ h cm 24  
Structure for juice dispenser coffee - Structure pour distributeur à jus brun - Struktur für Saftdispenser Caffè - Estructura para dispensador de zumos marron



Cod. 518D0006  
BASE DISTR. SUCCHI CARBONE h cm 24  
Structure for juice dispenser coal - Structure pour distributeur à jus gris - Struktur für Saftdispenser Carbone - Estructura para dispensador de zumos gris



## DISTRIBUTORE SUCCHI It 5

Juice and cold drink dispenser.

Fontaine à jus de fruits simple paroi.

Spender für Saft und kalte Getränke.

Surtidor de zumos y bebidas con grifo Tomlinson.



## LA PARTE FUNZIONALE



Cod. F1805420  
DISTRIBUTORE SUCCHI It 7  
Juice and cold drink dispenser - Fontaine à jus de fruits simple paroi - Spender für Saft und kalte Getränke - Surtidor de zumos y bebidas con grifo Tomlinson

### COMPOSIZIONE:

Cod. 97150864  
1 CONTENITORE IN VETRO  
CON RUBINETTO It 7  
Juice dispenser with tap - Fontaine à jus de fruits avec robinet - Saftspender mit shahn - Surtidor de zumos con grifo

Cod. 97150865  
1 VASCHETTA PER DISTRIB. SUCCHI  
Juices bowl distributor - Petit bac pour fontaine à jus - Schale für Saftspender - Cubeta de surtidor de zumos

Cod. 97150866  
1 COPERCHIO PER VASCHETTA  
DISTR. SUCCHI  
Lid for juices bowl distributor - Couvercle petit bac pour fontaine à jus - Deckel für Saftspender - Tapa por cubeta de surtidor de zumos

Cod. 97150867  
1 GEL PACK cm 15x14  
Refrigerating brick - Briquette réfrigérante - Kühlakku - Refrigerad

Cod. 5BA16020  
1 BACINELLA GN 1/6 h 20  
Gastronorm basin - Bac gastronorm - Durchbrochener basis - Cubeta gastronómico

Cod. 50902613  
1 GRIGLIA 1/6 PER DISTRIBUTORE  
Grill for dispenser - Grille pour distributeur - Rost für Getränkedispenser - Baño maria gastronómico

## LE BASI



Cod. 518A0006  
BASE DISTRIBUT. SUCCHI SALVIA h cm 24  
Structure for juice dispenser sage - Structure pour distributeur à jus vert - Struktur für Saftdispenser Salvia - Estructura para dispensador de zumos verde



Cod. 518B0006  
BASE DISTRIBUT. SUCCHI BURRO h cm 24  
Structure for juice dispenser cream - Structure pour distributeur à jus crème - Struktur für Saftdispenser Burro - Estructura para dispensador de zumos crema



Cod. 518C0006  
BASE DISTRIBUT. SUCCHI CAFFÈ h cm 24  
Structure for juice dispenser coffee - Structure pour distributeur à jus brun - Struktur für Saftdispenser Caffè - Estructura para dispensador de zumos marron



Cod. 518D0006  
BASE DISTR. SUCCHI CARBONE h cm 24  
Structure for juice dispenser coal - Structure pour distributeur à jus gris - Struktur für Saftdispenser Carbone - Estructura para dispensador de zumos gris



## DISTRIBUTORE SUCCHI It 7

Juice and cold drink dispenser.

Fontaine à jus de fruits simple paroi.

Spender für Saft und kalte Getränke.

Surtidor de zumos y bebidas con grifo Tomlinson.



## LA PARTE FUNZIONALE



Cod. F1809527  
DISTRIBUTORE BEVANDE CALDE It 5  
Hot drinks dispenser provided with electric resistance - Distributeurs de boissons chaudes avec résistance électrique - Spender für warme getränke ausgestattet mit elektrischer heizung - Distribuidores de bebidas calientes con resistencia eléctrica

## COMPOSIZIONE:

Cod. F0959524  
1 DISTRIB. BEVANDE CALDE C/MANIGLIE It 5  
Hot drink dispenser - Distributeur de boissons chaudes - Spender für warme getränke - Rejilla para dispensador

Cod. 5BA16020  
1 BACINELLA GN 1/6 h 20  
Gastronorm basin - Bac gastronorm - Durchbrochener basis - Cubeta gastronómica

Cod. F0959516  
1 GRIGLIA 1/6 PER DISTRIBUTORE  
Grill for dispenser - Grille pour distributeur - Rost für Getränkedispenser - Baño maria gastronómico

Cod. F1803116  
1 COPERCHIO PER DISTR. BEVANDE CALDE  
Lid for dispenser - Couvercle pour distributeur - Deckel für dispenser - Tapa para dispensador

Cod. 97150221  
1 RUBINETTO SMONT. IN PPL TOMLINSON  
Tomlinson PPL faucet - Robinet démontable en PPL Tomlinson - Abnehmbarer hahn aus PPL Tomlinson - Grifo desmontable de PPL Tomlinson

Cod. 97150870  
1 RESISTENZA ELETTRICA  
C/REGOLATORE 140 W  
Electric resistance - Résistance électrique - Elektrischer Widerstand - Resistencia eléctrica

## LE BASI



Cod. 518A0007  
BASE DISTRIBUT. BEVANDE CALDE SALVIA  
Structure for hot drink dispenser sage - Struct. pour distrib. à boissons chaudes vert - Struktur für warme Getränke Dispenser Salvia - Estructura para disp. de bebidas calientes verde



Cod. 518B0007  
BASE DISTRIBUT. BEVANDE CALDE BURRO  
Structure for hot drink dispenser cream - Struct. pour distrib. à boissons chaudes crème - Struktur für warme Getränke Dispenser Burro - Estructura para disp. de bebidas calientes crema



Cod. 518C0007  
BASE DISTRIBUT. BEVANDE CALDE CAFFÈ  
Structure for hot drink dispenser coffee - Struct. pour distrib. à boissons chaudes brun - Struktur für warme Getränke Dispenser Caffè - Estructura para disp. de bebidas calientes marron



Cod. 518D0007  
BASE DISTR. BEVANDE CALDE CARBONE  
Structure for hot drink dispenser coal - Struct. pour distrib. à boissons chaudes gris - Struktur für warme Getränke Dispenser Carbone - Estructura para disp. de bebidas calientes gris



## DISTRIBUTORE BEVANDE CALDE CON RESISTENZA ELETTRICA It 5

Hot drinks dispenser provided with electric resistance.  
Distributeurs de boissons chaudes avec résistance électrique.  
Spender für warme getränke ausgestattet mit elektrischer heizung.  
Distribuidores de bebidas calientes con resistencia eléctrica.



## COMPOSIZIONE

1 PORTA BROCCHIE h cm 7,5  
Jug holder  
Porte-carafes  
Krughalter  
Porta-jarras  
Cod. 518A9818 SALVIA / sage  
Cod. 518B9818 BURRO / cream  
Cod. 518C9818 CAFFÈ / coffee  
Cod. 518D9818 CARBONE / coal

Cod. 97150305  
1 VASCHETTA RACCOGLI GOCCE  
Drop-saver bowl  
Bac à goutess  
Tropfschale  
Cubeta de recoger gotas

Cod. 97150276  
2 GEL PACK cm 20x9,8  
Refrigerating brick  
Briquette réfrigérante  
Kühlakku  
Refrigerad

Cod. 97150861  
1 COPERCHIO INOX PER  
VASCHETTA RACCOGLI GOCCE  
Drop-saver lid for drop-saver bowl  
Couvercle por bac à goutes  
Edelstahlabdeckung für Tropfschale  
Tapa de acero por cubeta de recoger gotas

Cod. 97150862  
3 CARAFFA CON COPERCHIO lt 2,2  
Jug with lid  
Carafe avec couvercle  
Karaffe mit Deckel  
Jarra con tapa



Cod. 518A9818  
DISTRIBUTORE CEREALI / SUCCHI SALVIA  
39x12,8x30 h cm  
Cereal dispenser sage.  
Distributeur à céréales vert.  
Cerealien-Spender Salvia.  
Dispensador de cereales verde.



Cod. 518B9818  
DISTRIBUTORE CEREALI / SUCCHI BURRO  
39x12,8x30 h cm  
Cereal dispenser cream.  
Distributeur à céréales crème.  
Cerealien-Spender Burro.  
Dispensador de cereales crema.



Cod. 518C9818  
DISTRIBUTORE CEREALI / SUCCHI CAFFÈ  
39x12,8x30 h cm  
Cereal dispenser coffee.  
Distributeur à céréales brun.  
Cerealien-Spender Caffè.  
Dispensador de cereales marron.



Cod. 518D9818  
DISTRIBUTORE CEREALI / SUCCHI CARBONE  
39x12,8x30 h cm  
Cereal dispenser coal.  
Distributeur à céréales gris.  
Cerealien-Spender Carbone.  
Dispensador de cereales gris.





PINTI *buffet*

---

CALEIDO

-

**Avete in mente un colore particolare?**

Possiamo realizzare le basi proprio con quel colore! Per prezzi, tempistiche e ordini minimi contattateci.

**Are you thinking about a particular colour?**

We can make bases using it! Contact us for prices, lead time and MOQ.



# RICAMBI

## Spare parts

- Cod. 97150856 CUPOLA RETTANGOLARE / Rectangular dome lid
- Cod. 97150857 PIASTRA INOX / Refrigerated stainless steel plate
- Cod. 97150858 TAGLIERE IN POLIPROPILENE cm 54,7x34,2 / Polypropilene board cm 54,7x34,2
- Cod. 97150859 TAGLIERE PANE IN NOCE CANALETTO cm 27,5x34,5 / Bread board cm 27,5x34,5
- Cod. 97150860 CESTA PANE IN TESSUTO / Woven bread basket
- Cod. 97150861 COPERCHIO VASCHETTA RACCOGLI GOCCE / Drop-saver lid for drop-saver bowl
- Cod. 97150305 VASCHETTA RACCOGLI GOCCE / Drop-saver bowl
- Cod. 97150862 CARAFFA CON COPERCHIO lt 2,2 / Jug with lid lt 2,2
- Cod. 97150863 CONTENITORE IN VETRO CON RUBINETTO LT 5 / Juice glass dispenser with tap lt 5
- Cod. 97150864 CONTENITORE IN VETRO CON RUBINETTO LT 7 / Juice glass dispenser with tap lt 7
- Cod. 97150865 VASCHETTA PER DISTRIBUTORE SUCCHI / Juices bowl distributor
- Cod. 97150866 COPERCHIO PER VASCHETTA DISTRIBUTORE SUCCHI / Lid for juices bowl distributor
- Cod. 97150867 GEL PACK cm 15x14 / Refrigerating brick cm 15x14
- Cod. 97150276 GEL PACK cm 20x9,8 / Refrigerating brick cm 20x9,8
- Cod. F0959516 DISTRIBUTORE BEVANDE CALDE C/MANIGLIE lt 5 / Hot drink dispenser lt 5
- Cod. F1803116 COPERCHIO PER DISTRIBUTORE BEVANDE CALDE / Lid for hot drink dispenser
- Cod. 97150221 RUBINETTO COMPLETO TOMLINSON / Tomlinson faucet
- Cod. 97150759 CESTA PANE RETTANGOLARE WENGE C/FORCELLA CON CUPOLA cm 52,5x32x29,5/ Wenge rectangular bread basket with hooks with cover cm 52,5x32x29,5
- Cod. 97150869 CESTA PANE RETTANGOLARE PAGLIA C/FORCELLA CON CUPOLA cm 52,5x32x29,5/ Paill rectangular bread basket with hooks with cover cm 52,5x32x29,5
- Cod. 97150870 RESISTENZA PER DISTRIBUTORE BEVANDE CALDE 140 W / Heater for hot drink dispenser 140 W
- Cod. 97150118 RESISTENZA CON REGOLATORE PER CHAFING DISH 230 V 700 W / Heater with adjuster for chafing dish 230 V 700 W
- Cod. 97200078 FORNELLETTA INOX / Stainless steel burner holder
- Cod. 97150071 SUPPORTO PER FRIZIONE CHAFING DISH / Friction support for chafing dish
- Cod. 97150023 FRIZIONE DESTRA CHAFING DISH / Friction right for chafing dish
- Cod. 97150023 FRIZIONE SINISTRA CHAFING DISH / Friction left for chafing dish
- Cod.90230815 TARGHETTA "LATTE - CAFFÈ" PER BROCCA Ø cm 6,5 / Plate "Milk - Coffee" for jug Ø cm 6,5
- Cod.90230810 TARGHETTA "LATTE - ACQUA CALDA" PER BROCCA Ø cm 6,5 / Plate "Milk - Hot Water" for jug Ø cm 6,5

# GASTRONORM

1/1    2/3    1/2    2/4    1/3    1/4    2/8    1/6    1/9

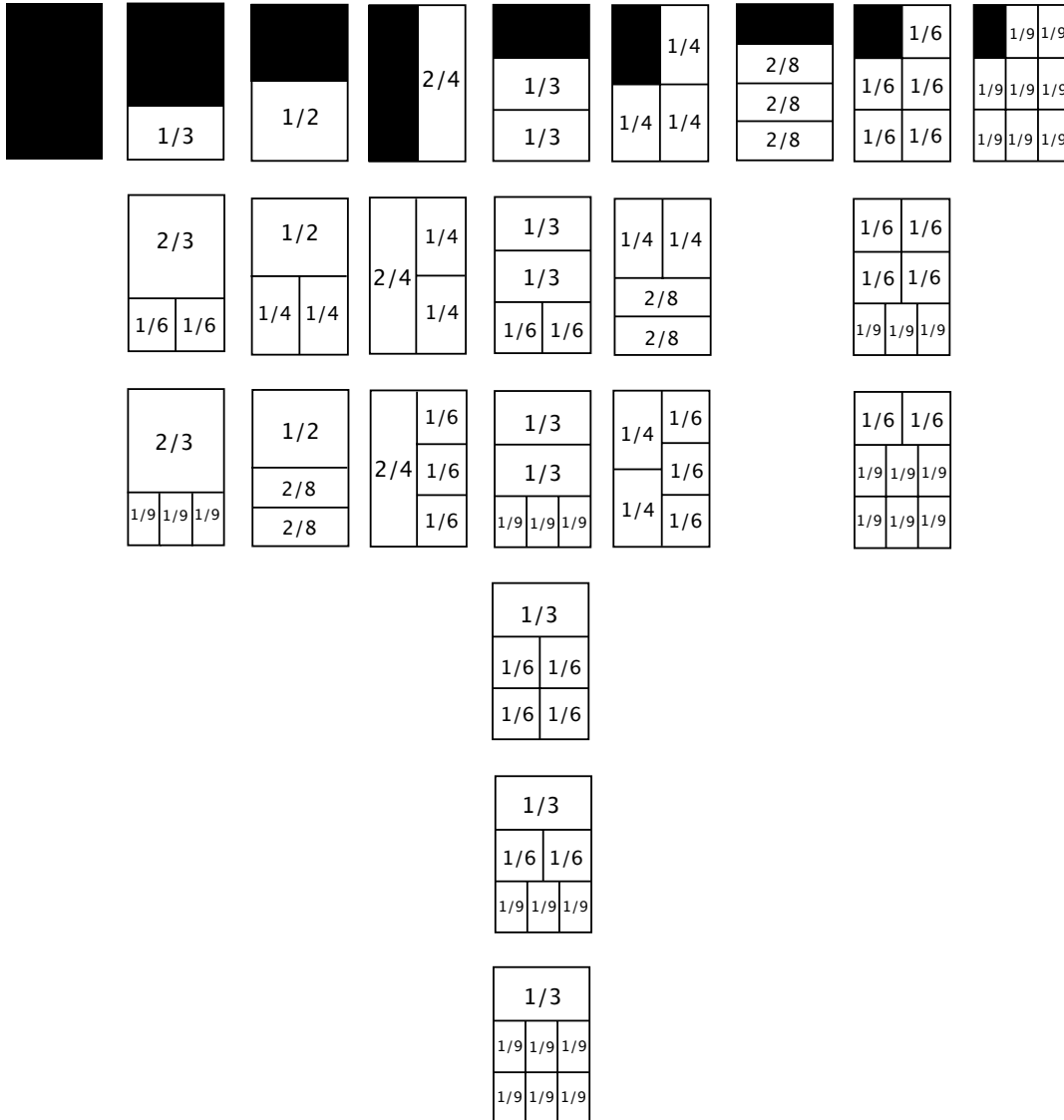

## ACCIAIO E SPESSORI

La serie Gastronorm è prodotta con acciaio AISI 304, chiamato anche 18/10, negli spessori:

- 1 mm per i modelli 2/1
- 0,7 e 0,8 per le altre pezzature restanti

## LUCIDATURA

Le altezze 100, 150, 200 sono sottoposte ad una operazione di normalizzazione termica e poi lucidate mediante burattatura. Oggetti di grandi dimensioni sono puliti per via elettrolitica. Le altezze 65, 40 e 20 e sottoposte a trattamento chimico che permette di ottenere una lucidatura omogenea su tutta la superficie.

## CONFEZIONE

Ogni singolo pezzo è sottoposto a lavaggio speculare ad alta temperatura 90° e confezionato in polipropilene pronto per l'uso già sterilizzato.

## CAPACITÀ

I raggi ridotti al min. offrono il max della capienza nel minimo ingombro.

## MATERIALI

Sono tutti certificati ed idonei al contatto con gli alimenti ai sensi dell' DM. 25-1-1992 art. 4-5° comma D.L. 208 e DIR. CEE 89/109.

## LAVAGGIO

Resistenti all'uso prolungato in lavastoviglie.

## MISURE

In accordo con gli standard internazionali della CEE doc. CEN/TC 194 EN631-1.

## THE STEEL AND THE THICKNESSES

The Gastronorm range is made of AISI 304 steel also called 18/10, in the following thicknesses:

- 1 mm for the 2/1 models
- 0,7 and 0,8 for the remaining sizes

## POLISHING

Heights 100, 150 and 200 are thermally normalised and then polished by tumbling. Large items are etch cleaned. Heights 65, 40 and 20 and are subjected to a chemical treatment permitting the attainment of even polishing over the entire surface.

## PACKAGING

Each individual piece is bright washed at the high temperature of 90° and packaged in polypropylene, ready for use already sterilised.

## CAPACITY

The finely rounded bottom edges offer maximum capacity in the minimum space.

## MATERIALS

All the materials are certified to be suitable for contact with foodstuffs according to DM. 25-1-1992 art. 4 - 5th para. D.L. 208 and EEC Directive 89/109.

## WASHING

Resistant to prolonged dish-washing.

## SIZES

In accordance with the international EEC standards doc. CEN/TC 194 EN631-1.

# NOTE INFORMATIVE Technical information

## ACCIAIO INOX 18/10

L'acciaio Inox 18/10 - Aisi 304 viene fornito esclusivamente dalle principali acciaierie europee. La sua eccezionale resistenza alla ruggine, la brillantezza e le caratteristiche igieniche soddisfano i requisiti della moderna gastronomia. Esso infatti resiste agli acidi contenuti nei prodotti alimentari, nei detersivi. L'acciaio Inox 18/10 è antiurto e particolarmente adatto al lavaggio in lavastoviglie.

## POLICARBONATO (PC)

Il policarbonato è un polimero di pregio che racchiude alcune caratteristiche della plastica, dell'acciaio e del vetro. La trasparenza si avvicina al 90%. La resistenza meccanica alla deformazione ha un'elevata resistenza all'urto. L'elevata stabilità dimensionale viene garantita fino ad una temperatura di 130 gradi. In presenza di fiamma è autoestinguente.

Avvertenze. Non resiste a: soluzioni alcaline, acetone, ammoniacca, benzolo ed alcool metilico. Il materiale è sicuro dal punto di vista fisiologico e può andare a contatto con gli alimenti.

## COMPONENTI IN LEGNO

Tutti i prodotti in legno sono realizzati in noce canaletto.

Avvertenze. Per mantenere a lungo la qualità del prodotto è necessario:

- Non immergere in liquidi o acqua
- Pulire con panno umido d'acqua
- Asciugare sempre con cura
- Evitare l'utilizzo di sostanze abrasive
- Tenere lontano da fiamme libere o fonti di calore
- Evitare l'esposizione prolungata al sole, per evitare variazione di colore e deformazioni.

NB. Il legno essendo un prodotto naturale può assumere tolleranze diverse a seconda della temperatura e dell'umidità presente nell'ambiente circostante. Sono possibili eventuali gradazioni di colore e venature in quanto prodotto in legno naturale.

## POLIPROPILENE

Il polipropilene è ad alta resistenza e garantito per alimenti.

## RESISTENZE

Sono adatte a un voltaggio di 220 Volts e dotate di spina schuko. Conformi alle leggi CEE. Per distributore bevande calde o chafing dish non utilizzare con contenitori vuoti. Per il corretto utilizzo e per la manutenzione fare comunque riferimento alle note presenti all'interno della confezione.

## 18/10 AISI 304 STAINLESS STEEL

18/10 AISI 304 stainless steel is supplied almost exclusively by the main European steelworks. Its exceptional rust resistance, its brilliance and hygienic qualities satisfy the requirements of modern gastronomy; in fact, it resists to the acids contained in foodstuffs, detergents and is shockproof. 18/10 steel is dishwasher safe.

## POLYCARBONATE (PC)

Polycarbonate is a valuable polymer that has some characteristics from plastics, steel and glass. Its transparency is close to 90%. Its strain strength has a high impact strength. Its high dimensional stability is guaranteed up to a 130-degree temperature. In the presence of flame, it is self-extinguishing.

Warning: it does not withstand: alkaline solutions, acetone, ammonia, benzol and methyl alcohol. The material is safe from the physiological point of view and can get in touch with food.

## WOOD COMPONENTS

All the wood products are made in Canaletto walnut.

Warning. To guarantee the quality of the product in the time:

- Do not plunge in liquids or in water
- Clean with a water-dampened cloth
- Dry with care
- Do not use abrasive agents or solvents
- Keep away from flames or heat sources
- Do not expose to the sun for a long-time to avoid colour changes and deformations.

N.B.Wood is a natural product and can have different tolerances according to the environment temperature and humidity.

This product made of natural wood may have different colour nuances and veins China is suitable for food usage and does not contain harmful substances or release dangerous elements.

## POLYPROPYLENE

Polypropylene is highly resistant and suitable for foodstuff.

## RESISTANCES

The electric resistance is suitable for 220 W voltage and are provided with schuko plug . In compliance with CEE norm. For hot drink dispenser and chafing dish. Do not use with empty drink dispenser and chafing dish. For a correct use please refer to the instructions leaflet inside the box.

# PINTI *buffet*

MADE IN ITALY

---

## CALEIDO

-

**2018**

PINTI INOX S.p.A.  
Via Antonini, 87  
25068 Sarezzo (BS) Italia  
Tel. +39 030 89351  
Fax +39 030 8935250  
+39 030 8901163  
pintinox@pinti.it  
[www.pinti.it](http://www.pinti.it)

PINTI INOX GMBH DEUTSCHLAND  
Römerstraße 91  
73066 Uhingen  
Tel +49 07161 93343-0  
Fax +49 07161 352789  
info@pinti.de  
[www.pinti.de](http://www.pinti.de)

-

Si ringrazia il ristorante *Nineteen - 19* a Brescia per l'ospitalità nelle foto ambientate.

*art director:* Daniele Ardisson  
*product manager:* Ruggero Borghetti  
*graphic design:* Elena Maccabiani  
*photos:* Claudio Sambinelli  
*cod. catalogo:* 98900455